

OPTIONAL EQUIPMENT: Reclinable trellis jib 6.2 / 12 m

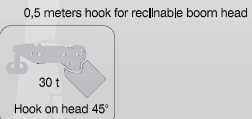

The lifting capacities in the structural area are based on DIN 15018 part 3 / FEM 5,004 / EN 13000.
 The lifting capacities in the stability area are based on DIN 15019 part 2 / ISO 4305 / EN 13000

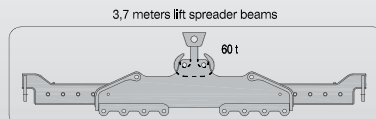
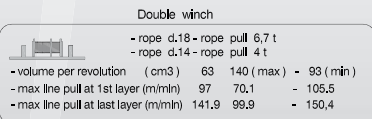
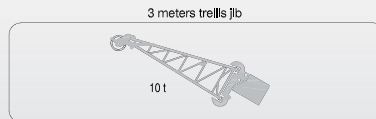
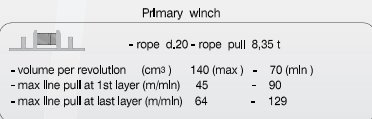
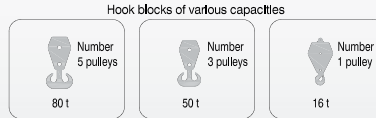
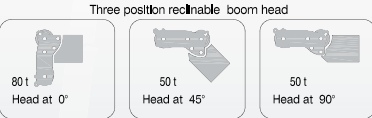
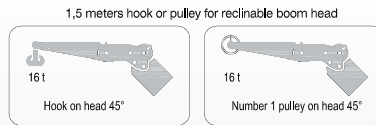
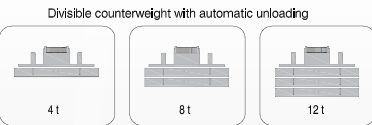
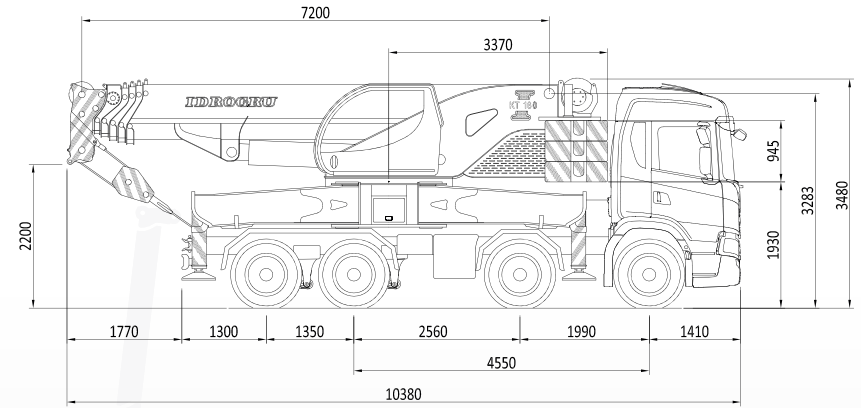
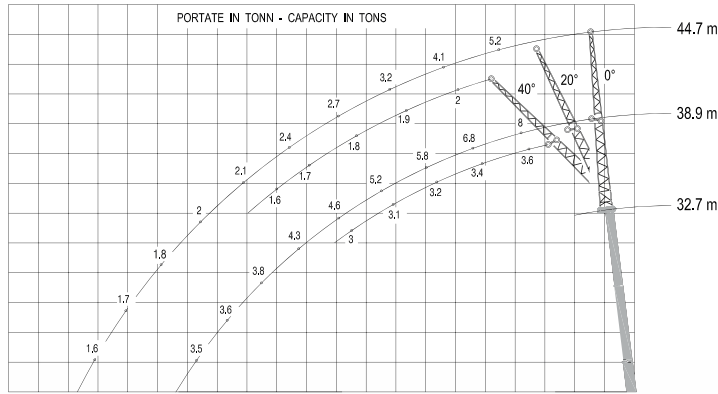